

2008

A Kinematics Based Tolerance Analysis of Mechanisms

Shahrbanoo Biabnavi Farkhondeh
Cleveland State University

How does access to this work benefit you? Let us know!

Follow this and additional works at: <http://engagedscholarship.csuohio.edu/etdarchive>

 Part of the [Mechanical Engineering Commons](#)

Recommended Citation

Farkhondeh, Shahrbanoo Biabnavi, "A Kinematics Based Tolerance Analysis of Mechanisms" (2008). *ETD Archive*. Paper 632.

This Thesis is brought to you for free and open access by EngagedScholarship@CSU. It has been accepted for inclusion in ETD Archive by an authorized administrator of EngagedScholarship@CSU. For more information, please contact library.es@csuohio.edu.

A KINEMATICS BASED TOLERANCE ANALYSIS OF MECHANISMS

SHAHRBANOO FARKHONDEH

Bachelor of Science in Mechanical Engineering

Tabriz University

Tabriz, Iran

July 1994

Submitted in partial fulfillment of requirements for the degree

MASTER OF SCIENCE IN MECHANICAL ENGINEERING

CLEVELAND STATE UNIVERSITY

MAY, 2008

This thesis has been approved
for the Department of Mechanical Engineering
and the College of Graduate Studies by:

Thesis Committee Chairperson, Dr. Majid Rashidi

Department, Date

Dr. Paul Lin

Department, Date

Dr. Hanz Richter

Department, Date

Dedicated to

To my beloved husband Dr. Davood Varghai, for understanding me and sharing with me his support and love.

To my Parents whom I see everywhere I look , and my Mom Always telling me: ”**You can do it**”

To my son, **Kaveh**, who is the most precious gift for me; his patience during my education has been amazing.

To my **brothers & sisters**, for they make me feel at home even though they are thousands of miles away from me.

To my best friend, Masoumeh Mozafri; who always shares my tears and laughters.

I dedicate, with all my heart, this research to all of you.

ACKNOWLEDGEMENT

I would like to give special thanks to my advisor Dr. **Majid Rashidi** for his support and guidance, not only in the development of this research, but also during the course of my graduate studies at Cleveland State University. His deep theoretical knowledge and practical experiences in many of the engineering subjects helped me to execute this research. His attitude and patience were the biggest assurance and encouragement during my study at CSU.

A special thanks to Dr. Paul Lin that helped me to start my Master Degree plan at Cleveland State University. He always helped me to find my way within the Mechanical Engineering Department. His invaluable comments and suggestions enhanced the quality of this thesis. This is an opportunity to extend my sincere appreciations to Dr. Hanz Richter, who also share in the enrichment of the material presented in this work. He always helped me a great deal when I was studying my technical courses in his classes.

Finally I want to extend my gratitude to all of the staff at Cleveland State University, at the department, college, and university levels, who helped made my graduate studies at CSU a pleasant and rewarding experience.

I APPRECIATE ALL OF THEM!!

A KINEMATICS BASED TOLERANCE ANALYSIS OF MECHANISMS

SHAHRBANOO FARKHONDEH

ABSTRACT

A kinematic based tolerance analysis of mechanisms is presented in this thesis. It is shown that standard kinematic analysis can be used for obtaining closed-form explicit formulations for tolerance analysis of mechanisms. It is proposed that the manufacturing tolerances are accounted for by incorporating fictitious sliding members in the rigid links, thereby allowing them to either “grow” or “shrink” along the lines of their pin connections. The virtual expansions or contractions of these fictitious sliders are captured in the kinematic equations by taking the differentials of the magnitudes of the vectors that define the length of rigid links having dimensional tolerances. These mathematical differentiations follow exactly the procedure of kinematic velocity analyses of mechanisms. The method can further be extended to perform tolerance analysis on a group of identical mechanisms. The tolerance analysis presented in this thesis was utilized to study tolerance accumulation in three (3) different mechanisms, slider crank, Scotch-Yoke, and a one-way clutch. In each case, the effect of tolerances in the individual components were combined together, through modified kinematic analyses, in order to determine the resulting accumulation of the tolerances in the assembly of the parts for any generalized configuration of the mechanisms. The analysis was further

extended to include statistical skewness analyses on the tolerance distributions of the individual components and the resulting skewness on the assembly of the mechanism. The main benefit of the presented approach is its allowance for the use of standard kinematic computer codes for tolerance analyses of mechanisms.

TABLES OF CONTENTS

	Page
ABSTRACT	V
LIST OF TABLES	X
LIST OF FIGURES	XI
LIST OF SYMBOLS	XII
CHAPTER I	INTRODUCTION
1.1	Background Information 1
1.2	Review of Previous Research 3
1.3	Problem statement 6
1.4	Contributions of this thesis..... 9
CHAPTER II	COMPARISON OF KINEMATIC AND TOLERANCE ANALYSIS
2.1	Kinematic analysis of a Slider-Crank mechanism..... 10
2.2	Tolerance analysis using a vector loop..... 14
2.3	Parametric study of the tolerance analysis of slider crank..... 17
2.4	Tolerance analysis of a group of slider crank assemblies 18
2.5	Summary 19

CHAPTER III	TOLERANCE ANALYSIS OF A SCOTCH-YOKE	
3.1	Configuration of a scotch-yoke mechanism.....	21
3.2	Kinematic analysis using a vector loop.....	22
3.3	Tolerance analysis using a vector loop.....	25
3.4	Parametric study of the tolerance analysis of Scotch-Yoke..	27
3.5	Tolerance analysis of a group of Scotch-Yoke assemblies.....	29
3.6	Summary.....	30
CHAPTER IV	TOLERANCE ANALYSIS OF A ONE-WAY CLUTCH	
4.1	Description of one-way clutch.....	31
4.2	Tolerance analysis of one-way clutch using a vector loop....	32
4.3	Parametric analysis of the tolerance analysis of one-way clutch assemblies.....	36
4.4	Summary	38
CHAPTER V	SKEWNESS ANALYSIS TOLERANCE STACK-UP FOR SLIDER-CRANK	
5.1	Skewness in tolerance analysis of planer mechanisms.....	39
5.2	Definition of skewness in statistical analysis.....	40
5.3	Skewness in tolerance stack-up for a group of slider-crank assemblies.....	43

	5.4	Parametric analysis of the skewness of slider-crank assemblies.....	47
	5.5	Summary	48
CHAPTER VI		CONCLUSION AND FUTURE WORK	
	6.1	Conclusions.....	50
	6.2	Future work.....	52
REFERENCES		53

LIST OF TABLES

Table		page
2-1	Dimensions and angular position data for numerical examples	14
3-1	Link lengths and angular position data for numerical examples.....	24
3-2	Link lengths and angular position data for numerical examples.....	28
3-3	Result of tolerance analysis of the Scotch-Yoke	29
4-1	Nominal dimensions and tolerances for the one-way clutch	37
5-1	Known parameters for skewness analysis of a slider crank	48
5-2	Skewness of the slider position and connecting rod angle.....	48

LIST OF FIGURES

Figure		page
1-a	A rigid link, AB, for kinematic analyses.....	8
1-b	Link AB with its fictitious slider, for tolerance analyses.....	8
2-1	Schematic view of a typical Slider-crank mechanism.....	11
2-2	Vector loop of the slider-crank mechanism.....	11
2-3	The slider-crank mechanism with fictitious sliders for tolerance analysis.....	15
3-1	Schematic view of a Scotch-Yoke mechanism.....	21
3-2	Vector loop of a Scotch-Yoke mechanism.....	22
3-3	A Scotch-Yoke mechanism with variable crank arm.....	25
4-1	Schematic view of a one-way clutch	31
4-2	Vector loop of the of a one-way clutch	31
5-1	Example of experimental data with non-zero skewness.....	41
5-2	Negative skew.....	42
5-3	Positive skew.....	42
5-4	Schematic view of a typical Slider-crank mechanism.....	43
5-5	Vector loop of the slider-crank mechanism.....	44
5-6	The slider-crank mechanism with fictitious sliders for tolerance analysis.....	44

LIST OF SYMBOLS

Symbol

r	Roller radius of the one-way clutch
dr	Tolerance of roller radius of the one-way clutch
r_2	Crank length, in (m).
dr_2	Tolerance for length r_2
r_3	Connecting rod length, in (m)
dr_3	Tolerance for length r_3
R	Ring radius of the one-way clutch
dR	Tolerance of ring radius of the one-way clutch
θ_2	Absolute angular position of the crank
$\dot{\theta}_2 = \omega_2$	Absolute angular velocity of the crank
$\ddot{\theta}_2$	Absolute angular acceleration of the crank
θ_3	Absolute angular position of the connecting rod
$\dot{\theta}_3 = \omega_3$	Absolute angular velocity of the connecting rod
$\ddot{\theta}_3$	Absolute angular acceleration of the connecting rod
α_2	Relative angular position of the crank
$d\alpha_2$	Tolerance for angle α_2
α_3	Relative angular position of the connecting rod
$d\alpha_3$	Tolerance for angle α_3

γ	Pressure angular of the one-way clutch
x	Linear position of the slider
dx	Tolerance for Linear position of the slider in the assembled linkage
\dot{x}	Linear velocity of the slider
\ddot{x}	Linear acceleration of the slider
h	Shoulder height of hub of the one-way clutch
dh	Shoulder height tolerance of hub of the one-way clutch
d	Contact distance of the one-way clutch
dd	Tolerance of contact distance of the one-way clutch
μ	The mean value of the random variation
σ	Standard deviation of the random variation
y	Skewness of the random variable

CHAPTER I

INTRODUCTION

1.1 Background Information

Tolerance analysis and tolerance control are important factors for manufacturing industries that attempt to increase productivity and improve the quality of their products. Not only do the machine part tolerances affect the ability to assemble the final product, but also they affect the production cost, process selection, tooling, setup cost, operator skills, inspection and gauging, and scrap and rework. Tolerances also directly affect engineering performance and strength of a design. Products of lower quality, excess cost, or poor performance will eventually lose out in the marketplace.

Design Engineering and manufacturing groups have competing tolerance requirements. Design engineers want tight tolerances to assure accurate performance; while manufacturing groups on the other hand prefers loose tolerances to reduce cost. It is essential to have a quantitative design tool for specifying tolerances and estimation of tolerance stack-up in machinery. Tolerance analysis brings the engineering design requirements and manufacturing capabilities together into a common ground, where the effects of tolerance specifications on both design and manufacturing requirements can be evaluated quantitatively.

Parts are always fabricated with dimensional tolerances; therefore assemblies will have their own tolerances. If the product has only one geometric configuration, then a simple tolerance stacking is sufficient. In case of machinery with moving parts there are multitudes of geometric configurations; therefore a simple tolerances stacking is no longer sufficient. The tolerance stacks should either be evaluated over-and-over for every possible geometric configuration; or a closed form tolerance formulation be developed. Tolerance variations in mechanisms depend upon their instantaneous configurations. For each new configuration of the mechanism, there exists a different tolerance accumulation.

1.2 Review of Previous Research

Statistical tolerance analysis offers powerful analytical methods for predicting the effects of manufacturing variations on performance and production cost. However, during the course of such tolerance analysis there are many factors to be considered. Statistical tolerance analysis is a multipart problem that must be carefully formulated to assure validity, and then carefully interpreted to accurately determine the overall effect on the entire manufacturing process. Kenneth W. Chase and Spencer P. Magleby [1] described a new method, called the Direct Linearization Method (DLM), that is presented for tolerance analysis of 2-D and 3-D mechanical assemblies, which generalizes vector loop-based models to account for small kinematic adjustments. This method has a significant advantage over traditional tolerance analysis methods in that it does not require an explicit function to describe the relationship between the resultant assembly dimension(s) and those of the manufactured components. Formulating an explicit assembly function may be difficult and not feasible for assemblies with many parts.

Huo [2] described a graphical method for tolerance analysis using polygons; these polygons are similar to velocity polygons used in traditional kinematics. This method has the advantage of being graphical in nature, and therefore intuitive. Lee and Gilmore [3] introduced a method similar to the Direct

Linearization Method to determine the kinematic analysis of mechanisms. These analyses are then directly used to determine the statistical variation of the kinematic properties of mechanism given link-length, pin-size, and pin clearance variations. Lee however didn't provide any justification for why the kinematic analyses are equivalent to the tolerance analyses.

A. Liou and P. Lin [4] presented a tolerance specification for robot kinematic parameters using the Taguchi method. Their method is based on identifying the significant parameters and in turn selecting the optimal tolerance range for each parameter. It also presents a step-by-step methodology for a systematic selection of tolerance range in robot design.

Hartenberg and Denavit [5] proposed closed form expressions to calculate the effect of each independent part variations on the total assembly variation by perturbing one design variable at a time. The tolerance sensitivity of each independent variable is the contribution of the variation of the individual variable divided by the total assembly variation. Knappe [6] calculated these sensitivities directly using partial derivatives of the closed form expression describing the configuration of the assembly. There are several disadvantages to both methods. Often, development of explicit expressions is difficult or not feasible for mechanisms with any degree of complexity. When these explicit expressions are mathematically derived, numerical techniques are often required to generate the

partial derivatives. Therefore, it is fair to conclude that these two methods are appropriate only for simple assemblies having a small number of members.

Marler [7] describes a method of tolerance analysis known as the Direct Linearization Method. It was based on linearizing the position equations of the assembly using a first order Taylor's series expansion. For two-dimensional mechanisms, each vector loop yields three constraint equations - closure in two orthogonal directions, and an angular closure. Using linear algebra to solve these equations leads to the matrix of tolerance sensitivities of the assembly to the tolerances of the corresponding independent variables. This matrix is used in forming root-sum-squares (RSS) expressions which describe the statistical tolerances of the assembly. This process has been incorporated into the CATS tolerance analysis software which has evolved into commercial CAD applications.

New CAD tools for tolerance evaluation are being developed and included with commercial CAD systems so that assembly tolerance specifications may be created with a graphical preprocessor and evaluated statistically. Built-in modeling aids, statistical tools, and a manufacturing process database will allow the non-experts to include manufacturing considerations in design decisions. Use of these new tools will reduce the number of manufacturing design changes, reduce product development time, reduce cost, and increase quality. They will

elevate tolerance analysis to the level of an accepted engineering design function, alongside finite element analysis, dynamic analysis, etc.

1.3 Problem statement

The goal of this thesis is to derive closed-form explicit formulations for tolerance analysis of mechanisms based on the conventional vector loop kinematic analyses. The motivation behind this approach is the availability of well established kinematic analyses computer codes that are already available in the market. In other words, the purpose of this thesis is to provide an answer for the following question. Is it possible to use the available kinematic formulations of mechanisms in a slightly modified manner and come up with a closed-form formulation for the tolerance analysis of a mechanism? As will be shown in subsequent chapters of this thesis, the answer to this question is “yes”. In order to introduce this approach and proceed with tolerance analysis of certain specific mechanism a brief review of kinematic analysis is presented next.

Kinematic analysis calculates position, velocity and acceleration of different members of a mechanism in response to its kinematic inputs, namely the input position, velocity and acceleration. In conventional kinematic analyses the dimensions of individual rigid members are specified as “constant” quantities. In

vector loop approach of kinematic analysis the vectors that represent the instantaneous positions of these rigid links have “constant” magnitude, with their angular orientation being a time dependent parameter. On the other hand, when a mechanism has a sliding member, such as a slider-crank, the vector that represents the instantaneous position of the slider is at least variable in its magnitude. **The essence of this thesis is to take advantage of this attribute of the kinematic formulation, namely vectors with variable length, and use that in the tolerance analysis of mechanisms.** In order to lay the ground for the tolerance analyses studies in this thesis a brief introduction of tolerance analysis is presented next.

Tolerance analysis determines the output variations of assemblies with dimensions that are permitted to vary according to an imposed tolerance. Alternatively, tolerance analysis can also be described as the geometric variation of one assembly relative to another; therefore, tolerance analysis applies to a “group” of identical mechanisms. In contrast, kinematic analysis describes the motion of a single assembly. Therefore, the differences between the two types of analysis make it difficult to directly use kinematic analysis in a tolerance analysis. Relationships between the two types of analysis must be established in order to use kinematic analysis for the purpose tolerance analysis.

A closer look at the dimensional variations (tolerances) of the rigid links of a mechanism due to their manufacturing process could lead us to consider these rigid members to be hypothetically augmented with fictitious sliding members. Figure 1 shows this concept. As shown in Figure 1-a, the link AB could be a rigid member of a mechanism; while Figure 1-b shows the same Link AB augmented with a fictitious slider. The potential of the “growth” or “shrinkage” of AB due to the existence of the fictitious slider can be interpreted as the manufacturing tolerance that can occur in the length of AB during the manufacturing process. This allows for formulation of tolerance analysis in a closed-form, with the possibility of accounting for length variation on the rigid links.

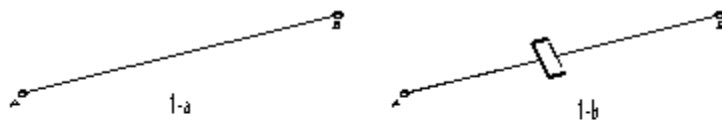

Figure 1-(a) A rigid link, AB, for kinematic analyses

Figure 1-(b) Link AB with its fictitious slider, for tolerance analyses

It is understood that upon inclusion of fictitious sliding members the total number of degrees of freedom (DOF) of the system will increase, thereby requiring more input parameters to obtain unique kinematic solutions. In contrast this is not a problem in tolerance analysis, because these additional input parameters are known; they are the imposed or known tolerances of the individual rigid members.

1.4 Contributions of this thesis

This thesis provides the foundation for the use of kinematic analysis in tolerance analysis of mechanisms and linkages. It describes a library of equivalent variation mechanisms based on assembly joints for modeling dimensional variation. It also provides a systematic method for analyzing tolerances for the full range of motion of mechanisms as well as static assemblies. The goal of this research is to determine the relationship between the kinematic analysis and the tolerance accumulation in the mechanism so that standard kinematic analysis software can be used to perform tolerance analysis of assemblies and mechanisms.

CHAPTER II

COMPARISON OF KINEMATIC AND TOLERANCE ANALYSIS

In order to show the similarity between kinematic and tolerance analysis the trivial kinematic formulation of slider crank mechanism is presented here. Such analysis is then modified in section 2.1 of this chapter to conduct tolerance studies.

2.1 Kinematic Analysis of a Slider-Crank Mechanism

The slider crank shown in Figure 2.1 is a typical mechanism with its position, velocity and acceleration equations easily derivable. In this chapter the relationship between kinematic and tolerance analysis is demonstrated. Kinematic analysis predicts the angular position, velocity and acceleration of the connecting rod and the rectilinear position, velocity and acceleration of the slider (link 4) in response to the kinematic input parameter of the crank (link 2) . An

appropriate vector loop for solving the kinematics of the slider crank is shown in Figure 2.2.

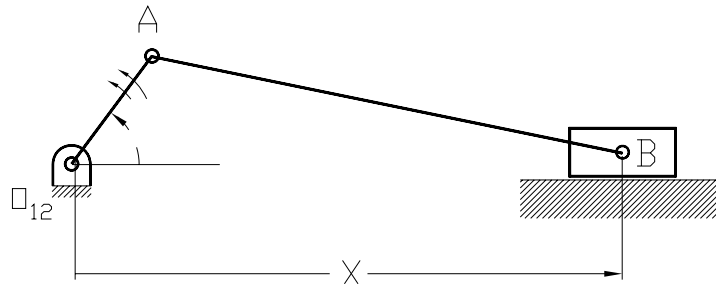

Figure 2-1 Schematic view of a typical slider crank mechanism

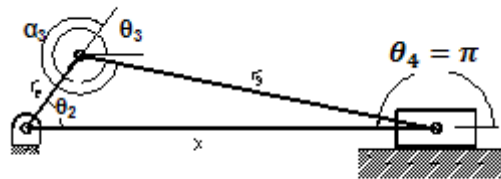

Figure 2-2 Vector loop of a slider crank mechanism

The vector loop showed in Figure 2-2 yield the following equations:

$$\begin{cases} r_2 \cos \theta_2 + r_3 \cos \theta_3 + x \cos \pi = 0 \\ r_2 \sin \theta_2 + r_3 \sin \theta_3 + x \sin \pi = 0 \end{cases} \quad (2-1)$$

In Equations 2-1 the values of θ_3 , x are unknown parameters, and the input parameter θ_2 is known for kinematic analysis.

The loop equations are then differentiated with respect to time yielding the following two equations:

$$\begin{cases} -r_2 \omega_2 \sin \theta_2 - r_3 \omega_3 \sin \theta_3 + \dot{x} (\cos \pi) = 0 \\ r_2 \omega_2 \cos \theta_2 + r_3 \omega_3 \cos \theta_3 = 0 \end{cases} \quad (2-2)$$

Where $\dot{\theta}_2 = \omega_2$ and $\dot{\theta}_3 = \omega_3$

Equations 2-2 may be represented in a matrix form as:

$$[A]\omega_2 + [B]\begin{Bmatrix} \omega_3 \\ \dot{x} \end{Bmatrix} = 0 \quad (2-3)$$

Where $A = \begin{bmatrix} -r_2 \sin \theta_2 \\ r_2 \cos \theta_2 \end{bmatrix}$, and $B = \begin{bmatrix} -r_3 \sin \theta_3 & -1 \\ r_3 \cos \theta_3 & 0 \end{bmatrix}$

Solving for the dependent variables ω_3 and \dot{x} Equations 2-4 are obtained:

$$\begin{Bmatrix} \omega_3 \\ \dot{x} \end{Bmatrix} = [-B^{-1} \ A] \omega_2 \quad (2-4)$$

Where:

$$R^{-1} = \frac{1}{|B|} \begin{bmatrix} 0 & -1 \\ -r_3 \cos \theta_3 & -r_3 \sin \theta_3 \end{bmatrix} = \frac{1}{0 - r_3 \cos \theta_3} \begin{bmatrix} 0 & 1 \\ -r_3 \cos \theta_3 & -r_3 \sin \theta_3 \end{bmatrix}$$

This results in a closed form solution for the unknown parameters as:

$$\begin{bmatrix} \omega_3 \\ \dot{\chi} \end{bmatrix} = \begin{bmatrix} 0 & \frac{1}{r_3 \cos \theta_3} \\ 1 & \frac{\sin \theta_3}{\cos \theta_3} \end{bmatrix} \begin{bmatrix} -r_3 \sin \theta_3 \\ r_3 \cos \theta_3 \end{bmatrix} \omega_2$$

For the slider crank mechanism with geometric dimensions and its instantaneous positions shown in Table 1 the numerical values of the solutions become:

$$\frac{\omega_3}{\omega_2} = \frac{1 \cos 45^\circ}{2 \cos 339.3^\circ} = 0.2626 \rightarrow \omega_3 = 0.2626$$

$$\frac{\dot{\chi}}{\omega_2} = 10(-\sin 45 + \cos 45(\tan(339.3)))$$

where the final solution may be written as:

$$\dot{\chi} = 10[-0.850 + 0.5253(-7.993)] = -33.487$$

$$\begin{bmatrix} \omega_3 \\ \dot{\chi} \end{bmatrix} = \begin{bmatrix} 0.2626 \\ -33.487 \end{bmatrix} \omega_2 \quad (2-5)$$

Table 2-1 Dimensions and angular position data for numerical examples.

	length	Absolute Angle	Relative Angle	Angle Velocity
Link	r_i	θ_i	α_i	ω_i
2	10"	$\frac{\pi}{4} = 45^\circ$	0	$1 \frac{\text{rad}}{\text{Sec}}$
3	20"	339.3°	294.3	$\omega_3 = ?$
4	?	$\pi = 180^\circ$	π	$X' = ?$

The $[-B^{-1} \ A]$ matrix is known as the Jacobian matrix. The rows of the Jacobian describe the ratio, or effect of ω_2 on ω_3 and \dot{x} . Thus, the Jacobian describes the kinematic sensitivity of the input ω_2 on the resulting angular velocities ω_3 and \dot{x} . Numerically, this means that the magnitude of ω_3 is 0.2626 of ω_2 , and \dot{x} is -33.487 of ω_2 .

In contrast, and for the purpose of this thesis, tolerance analysis of this mechanism is defined as prediction of the variation in the angular position of link 3 and the variation of the rectilinear position of link 4 in response to dimensional variation in the length of link 2 and 3.

2.2 Tolerance Analysis using a vector loop

In tolerance analysis, small changes in geometric dimensions, caused by manufacturing variation, reveal the resulting variations in the system's configuration from its nominal configuration. Such variations accumulate, or

stack up, in an assembly resulting in poor performance or badly fitting parts. To allow for tolerance stack up to be transmitted through the vector chain, the angular position of each vector is defined relative to the preceding vector by means of the relative angles α_i as shown in Figure 2-3.

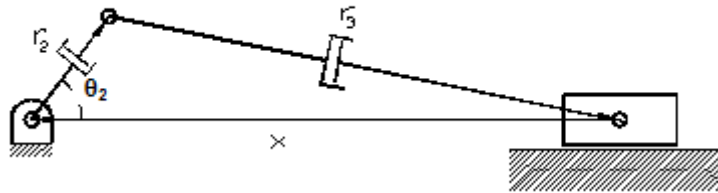

Fig 2-3 - The slider crank mechanism with fictitious sliders for tolerance analysis

In order to examine the tolerance sensitivity of the slider crank mechanism as shown in Figure 2-3, the crank and connecting links r_2 and r_3 are allowed to be variable in length. This of course increases the number of degrees-of-freedom of the system from 1 to 3. However in this section our purpose is not kinematic analysis but tolerance analysis. The components of the vector loop shown in Figure 2-3 are described by equation 2-6:

$$\begin{cases} r_2 \cos \theta_2 + r_3 \cos \theta_3 + x \cos \pi = 0 \\ r_2 \sin \theta_2 + r_3 \sin \theta_3 + x \sin \pi = 0 \end{cases} \quad (2-6)$$

Where α_2 and α_3 are the relative angles between adjacent links.

Let $\theta_2 = (\theta_1 + \alpha_2)$ and further for slider crank $\theta_1 = 0$,

$$\theta_2 = \alpha_2, \quad \theta_3 = (\theta_2 + \alpha_3) \quad (2-7)$$

Rewriting Equations 2-7 in terms of the relative angles yield:

$$\begin{cases} r_2 \cos \alpha_2 + r_3 \cos(\theta_2 + \alpha_3) + x \cos \pi = 0 \\ r_2 \sin \alpha_2 + r_3 \sin(\theta_2 + \alpha_3) + x \sin \pi = 0 \end{cases}$$

Now following the conventional kinematic analysis, let's take geometric variation of Equation 2-6.

By taking the differentials of r and α Equations 2-8 are obtained:

$$\begin{cases} dr_2 \cos \alpha_2 - r_2 d\alpha_2 \sin \alpha_2 + dr_3 \cos(\theta_2 + \alpha_3) - r_3 d\alpha_3 \sin(\theta_2 + \alpha_3) + dx \cos \pi = 0 \\ dr_2 \sin \alpha_2 + r_2 d\alpha_2 \cos \alpha_2 + dr_3 \sin(\theta_2 + \alpha_3) + r_3 d\alpha_3 \cos(\theta_2 + \alpha_3) + dx \sin \pi = 0 \end{cases} \quad (2-8)$$

Here, dr 's and $d\alpha$'s represent small changes in the lengths and angles respectively.

In Equation 2.8 dr_2 and dr_3 represent the manufacturing variations (tolerances) that are resulted during the fabrications of the crank and connecting rod respectively. Furthermore, the values of dr_2 , dr_3 and $d\alpha_2$ are known. This will

make $d\alpha_3$ and dx as the two unknown parameters which are the resulting output or "assembly tolerances" of the mechanism.

Equations 2-8 may be expressed in matrix form as:

$$[A] \begin{Bmatrix} d\alpha_2 \\ dr_2 \\ dr_3 \end{Bmatrix} + B \begin{Bmatrix} d\alpha_3 \\ dx \end{Bmatrix} = 0 \quad (2-9)$$

$$\begin{Bmatrix} d\alpha_3 \\ dx \end{Bmatrix} = [-B^{-1} \quad A] \begin{Bmatrix} d\alpha_2 \\ dr_2 \\ dr_3 \end{Bmatrix} = [S_{ij}] \begin{Bmatrix} d\alpha_2 \\ dr_2 \\ dr_3 \end{Bmatrix} \quad (2-10)$$

The [A] and [B] matrices of Equation 2-10 are the coefficient matrix of the independent and dependent variables respectively and are expressed in Equations 2-11.

$$A = \begin{bmatrix} -r_2 \sin \alpha_2 & \cos \alpha_2 & \cos \theta_2 \\ r_2 \cos \alpha_2 & \sin \alpha_2 & \sin \theta_2 \end{bmatrix} \text{ and } B = \begin{bmatrix} -r_3 \sin(\theta_2 + \alpha_3) & -1 \\ r_3 \cos(\theta_2 + \alpha_3) & 0 \end{bmatrix} \quad (2-11)$$

The combination of [A] and [B] matrices form the tolerance sensitivity matrix [S] of Equations 2-10.

The [S] matrix defines the variation $d\alpha_3$ and dx as the sum of the fractions of the variations $d\alpha_2$, dr_2 and dr_3 . Matrices [A] and [B] may be substituted from Equations 2-11 into 2-10 in order to obtain a closed form solution for $d\alpha_3$ and dx .

2.3 Parametric study of the tolerance analysis of slider crank

In Section 2.2 a closed-form formulation was derived for tolerance analysis of a slider crank mechanism. This section presents a parametric study of this tolerance analysis for a set of geometric dimensions and their corresponding tolerances of the mechanism. Table 2.1 contains the geometric dimensions of the mechanism. Here, let's postulate a length variation of 0.005" in each of the crank and connecting rod lengths. Using the closed form formulations of Section 2.2 we can obtain the resulting variations in α_3 and x for any configuration of the mechanism.

Substituting the numerical values of the known parameters in Equations 2-10 yield:

$$\begin{aligned} \begin{pmatrix} d\alpha_3 \\ dx \end{pmatrix} &= \begin{bmatrix} 0 & 0.05 \\ -1 & -8 \end{bmatrix} \begin{bmatrix} -8.5 & 0.52 & 0.96 \\ 5.2 & 0.85 & 7.99 \end{bmatrix} \begin{pmatrix} da_1 \\ dr_1 \\ dr_2 \end{pmatrix} \\ \begin{pmatrix} d\alpha_3 \\ dx \end{pmatrix} &= \begin{bmatrix} 0.26 & 0.043 & 0.40 \\ -33.1 & -7.32 & -64.88 \end{bmatrix} \begin{pmatrix} 0 \\ 0.005 \\ 0.005 \end{pmatrix} = \begin{pmatrix} 0.002215 \\ -0.361 \end{pmatrix} \quad (2-12) \end{aligned}$$

2.4 Tolerance analysis of a group of slider crank assemblies

The above calculations represent a single case tolerance analysis for given geometric configuration. To predict the tolerance stack up statistically in a group

of assemblies, we can use the above presented calculations for the conventional statistical Root-Sum-Square analysis:

$$d\alpha, x = \sqrt{\sum (S_{i,j} du_j)^2} \quad (2-13)$$

where du_j is the probable error in the input position $d\alpha_2$, dx_2 and dx_3 . Equation 2-13 is based on a 3σ tolerances of the manufacturing process used to produce the part dimensions. Equation 2-13 comes from statistical error analysis where probability distributions are added by adding variances, which are the standard deviation squared. For the slider crank analyzed in this section the results become:

$$d\alpha_3 = \sqrt{(0.26d\alpha_2)^2 + (0.043dx_2)^2 + (0.4dx_3)^2} \quad (2-14)$$

$$dx = \sqrt{(-33.1d\alpha_2)^2 + (-7.32dx_2)^2 + (-64.88dx_3)^2}$$

2.5 Summary

In this chapter we showed that standard kinematic analysis can be used for tolerance analysis of a slider crank mechanism. The method is however applicable to any mechanism with any number of degrees of freedom. In the presented approach, the manufacturing tolerances are accounted for by incorporating fictitious sliding members in the rigid links, thereby allowing them to either “grow” or “shrink” along the lines of their pin connections. The virtual

expansions or contractions of these fictitious sliders can be captured in by taking the differential of the magnitudes of the vectors that define the length of rigid links having dimensional tolerances. These mathematical differentiations follow exactly the procedure of kinematic velocity analyses of mechanisms. The method can further be extended to perform tolerance analysis on a group of identical mechanisms.

As the fictitious sliders are added to the rigid members of a mechanism, a modified linkage is constructed with higher number of degrees of freedom (DOF) that requires higher number of kinematic input parameters in order to obtain unique kinematic solutions. The extra required input parameters however are the known tolerances of the individual parts that result in obtaining a unique solution for the tolerance analysis of a mechanism in a general explicit form for any configuration of the system.

CHAPTER III

TOLERANCE ANALYSIS OF A SCOTCH-YOKE

3.1 Configuration of a scotch -yoke Mechanism

The purpose of this chapter is to conduct dimensional tolerance analysis for a Scotch-Yoke mechanism. Figure 3-1 shows a schematic representation of a typical Scotch-Yoke mechanism.

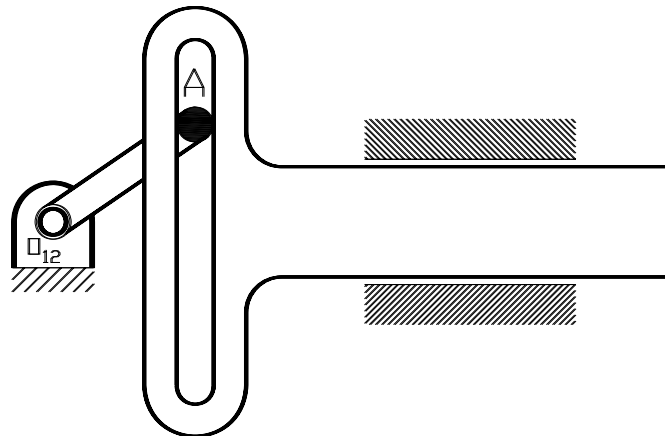

Figure 3-1 Schematic view of a Scotch-Yoke mechanism

The **Scotch Yoke** is a mechanism for converting the linear motion of a slider into rotational motion of a crank or vice-versa. The slider part is directly coupled to a reciprocating yoke with a slot that engages a pin on the rotating part, as shown in the Figure 3-1. An appropriate vector loop for solving the kinematics of the scotch-yoke is shown in Figure 3-2.

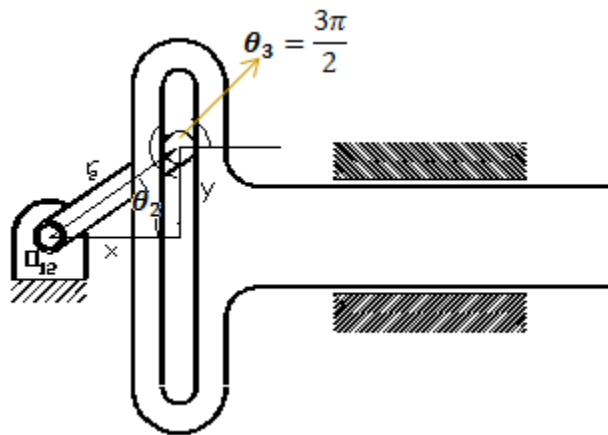

Figure 3-2 Vector loop of a Scotch-Yoke mechanism

3.2 Kinematics analysis using a vector loop

Vector loop showed in Figure 3-2 yields the following equations:

$$\begin{cases} r_2 \cos\theta_2 + x \cos\pi = 0 \\ r_2 \sin\theta_2 + y \sin\frac{3\pi}{2} = 0 \end{cases} \quad (3-1)$$

The loop equations are then differentiated with respect to time yielding the following two equations:

$$\begin{cases} -r_2 \omega_2 \sin \theta_2 + \dot{x} \cos \pi = 0 \\ r_2 \omega_2 \cos \theta_2 + \dot{y} \sin \frac{3\pi}{2} = 0 \end{cases} \quad (3-2)$$

$$\begin{cases} -r_2 \omega_2 \sin \theta_2 - \dot{x} = 0 \\ r_2 \omega_2 \cos \theta_2 - \dot{y} = 0 \end{cases} \quad (3-3)$$

θ_2, ω_2 are the known for the position and velocity analysis respectively.

$$[A]\omega_2 + B \begin{Bmatrix} \dot{x} \\ \dot{y} \end{Bmatrix} = 0 \quad (3-3)$$

$$\begin{Bmatrix} \dot{x} \\ \dot{y} \end{Bmatrix} = [-B^{-1} \quad A]\omega_2$$

Where $A = \begin{bmatrix} -r_2 \sin \theta_2 \\ r_2 \cos \theta_2 \end{bmatrix}$, and $B = \begin{bmatrix} -1 & 0 \\ 0 & -1 \end{bmatrix}$

$$B^{-1} = \frac{1}{1-0} \begin{bmatrix} -1 & 0 \\ 0 & -1 \end{bmatrix}$$

Solving for the dependent variables \dot{x} and \dot{y} .

$$\begin{Bmatrix} \dot{x} \\ \dot{y} \end{Bmatrix} = \begin{bmatrix} 1 & 0 \\ 0 & 1 \end{bmatrix} \begin{bmatrix} -r_2 \sin \theta_2 \\ r_2 \cos \theta_2 \end{bmatrix} \omega_2$$

For the scotch-yoke mechanism with link length and position with parameters shown in Table 3.1 the results of the kinematic analysis are:

$$\begin{Bmatrix} \dot{x} \\ \dot{y} \end{Bmatrix} = \begin{bmatrix} 1 & 0 \\ 0 & 1 \end{bmatrix} \begin{bmatrix} -8.5 \\ 5.2 \end{bmatrix} \omega_2 \quad \begin{Bmatrix} \dot{x} \\ \dot{y} \end{Bmatrix} = \begin{bmatrix} -8.5 \\ 5.2 \end{bmatrix}$$

Table 3-1 Link lengths and angular position data for numerical examples.

	length	Absolute Angle	Relative Angle	Angle Velocity
Link	r_i	θ_i	α_i	ω_i
2	10°	$\frac{\pi}{4} = 45^{\circ}$	0	$1 \frac{\text{rad}}{\text{Sec}}$
y	-	$3\pi/2$	$\pi/2 + \theta_2$	-
x	-	$\pi = 180^{\circ}$	π	$\dot{X} = ?$

3.3 Tolerance analysis using a vector loop

For tolerance analysis of a Scotch Yoke, we must allow r_2 to be variable (no longer constant). The angular position of each vector is defined relative to the preceding vector by means of the relative angles α_i as shown in Figure 3-3.

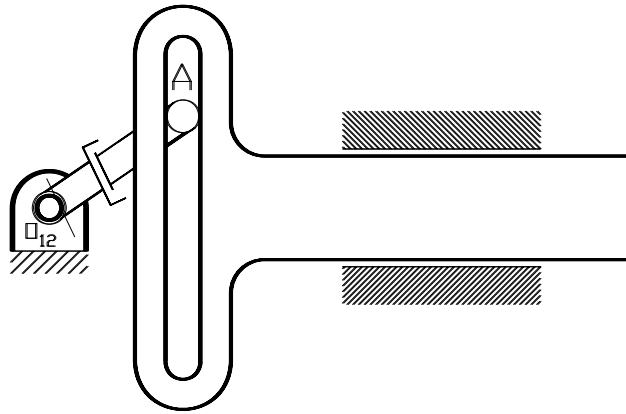

Fig 3-3 A scotch-Yoke mechanism with variable crank arm

The vector loop of Figure 3-2 yields the following vector equations for the mechanism shown in Figure 3-3:

$$\begin{cases} r_2 \cos \theta_2 + x \cos \pi = 0 \\ r_2 \sin \theta_2 + y \sin \frac{3\pi}{2} = 0 \end{cases} \quad (3-6)$$

Where α_2 is the relative angle between the crank and slider links. Using the definitions of the relative angles as: $\theta_2 = \alpha_2$ and $\theta_3 = \theta_2 + \alpha_3$ Equation 3-6 may be represented as:

$$\begin{cases} r_2 \cos \alpha_2 + x \cos \pi = 0 \\ r_2 \sin \alpha_2 + y \sin \frac{3\pi}{2} = 0 \end{cases} \quad (3-7)$$

Unlike Equation 3-1 in which r_2 was a constant parameter, here, in tolerances analysis r_2 must be allowed to vary. Taking the differential of Equation 3-7 yields:

$$\begin{cases} dr_2 \cos \alpha_2 - r_2 d\alpha_2 \sin \alpha_2 + dx \cos \pi = 0 \\ dr_2 \sin \alpha_2 + r_2 d\alpha_2 \cos \alpha_2 + dy \sin \frac{3\pi}{2} = 0 \end{cases} \quad (3-8)$$

where dr_2 and $d\alpha_2$ represent small changes in the lengths and angles respectively.

Here dr_2 represents the tolerance that can be specified for the crank arm. The value of dr_2 must be specified by designer. Ultimately, the purpose of this analysis is to estimate the influence of dr_2 in the variation of the slider location dx and the pin location dy .

It is desired to determine the variation in x and y in terms of the imposed tolerances in the crank arm r_2 .

Equations 3-8 may be represented in a matrix form as:

$$[A] \begin{Bmatrix} d\alpha_2 \\ dr_2 \end{Bmatrix} + [B] \begin{Bmatrix} dx \\ dy \end{Bmatrix} = 0 \quad (3-9)$$

Here [A] and [B] are the coefficient matrix of the independent and dependent variables respectively, which combine to form the tolerance sensitivity matrix [S] as shown in Equation 3-10:

$$\begin{Bmatrix} dx \\ dy \end{Bmatrix} = [-B^{-1}A] \begin{Bmatrix} d\alpha_2 \\ dr_2 \end{Bmatrix} = [S_{IJ}] \begin{Bmatrix} d\alpha_2 \\ dr_2 \end{Bmatrix} \quad (3-10)$$

3.4 Parametric study of the tolerance analysis of Scotch-Yoke

In Section 3-2 a closed-form formulation was derived for tolerance analysis of a Scotch-Yoke. This section presents a parametric study of this tolerance analysis for a set of geometric dimensions and their corresponding tolerances of the mechanism. Table 3-2 contains the geometric dimensions and the specified tolerances for the parts that are manufactured.

Table 3-2 Link lengths and angular position data for numerical examples.

	length	Absolute Angle	Relative Angle	Tolerances
--	--------	----------------	----------------	------------

Link	r_i	θ_i	α_i	---
2	10°	$\frac{\pi}{4} = 45^\circ$	0	$dr_2=0.005''$
y	-	$3\pi/2$	$\pi/2 + \theta_2$	$dy = ?$
x	-	$\pi = 180^\circ$	π	$dx = ?$

The known parameters of Table 3-2 are employed to find the solutions for Equations 3-10.

Table 3-3 contains the results of this parametric study. For the Scotch-Yoke mechanism with parameters shown in Table 3.2, solving for the dependent variables dx and dy yields:

$$-B^{-1} = \frac{1}{-1} \begin{bmatrix} -1 & 0 \\ 0 & -1 \end{bmatrix} = \begin{bmatrix} 1 & 0 \\ 0 & 1 \end{bmatrix}$$

$$\begin{Bmatrix} dx \\ dy \end{Bmatrix} = \begin{bmatrix} 1 & 0 \\ 0 & 1 \end{bmatrix} \begin{bmatrix} -r_2 \sin \theta_2 & \cos \theta_2 \\ r_2 \cos \theta_2 & \sin \theta_2 \end{bmatrix} \begin{Bmatrix} d\alpha_2 \\ dr_2 \end{Bmatrix}$$

$$\begin{Bmatrix} dx \\ dy \end{Bmatrix} = \begin{bmatrix} 1 & 0 \\ 0 & 1 \end{bmatrix} \begin{bmatrix} -8.5 & 0.525 \\ 5.25 & 0.85 \end{bmatrix} \begin{Bmatrix} 0 \\ 0.005 \end{Bmatrix}$$

$$\begin{Bmatrix} dx \\ dy \end{Bmatrix} = \begin{bmatrix} -8.5 & 0.525 \\ 5.25 & 0.85 \end{bmatrix} \begin{Bmatrix} 0 \\ 0.005 \end{Bmatrix} = \begin{Bmatrix} -0.002625 \\ 0.00425 \end{Bmatrix} \quad (3-11)$$

Table 3-3 Result of tolerance analysis of the Scotch-Yoke

dx	dy
-0.002625	0.00425

3.5 Tolerance analysis of a group of Scotch-Yoke assemblies

The tolerance analysis presented in Section 3.3 is for a single Scotch-Yoke mechanism. To predict the tolerance stack-up statistically in a group of assemblies, the definition of standard deviation may be used as follow:

$$dy,x = \sqrt{\sum (S_{ij} du_j)^2} \quad (3-12)$$

Where du_j is the probable error in the input position dr_2 and $d\alpha_2$ are the 3σ tolerances of the manufacturing process used to produce the part lengths. This comes from statistical error analysis where probability distributions are added by adding variances, which are the standard deviation squared. For the Scotch-Yoke described in Table 3.1 the values of stack-up tolerances in a group of assemblies are:

$$dx = \sqrt{(9.5d\alpha_2)^2 + (0.525dr_2)^2} \quad (3-13)$$

$$dy = \sqrt{(0.525d\alpha_2)^2 + (0.85dr_2)^2}$$

The values of dx and dy presented in Equation 3-13 are the variations in position of the slider and the pin of the mechanism for a group of assemblies.

3.6 Summary

In this chapter conventional kinematic analysis was employed to conduct tolerance analysis of a Scotch-Yoke mechanism. The only member with a potential tolerance in its geometric dimension was assumed to be the crank arm of the mechanism. This increased the degree of freedom of the system from one (1) to two (2). The additional required input was taken as the prescribed tolerance in the length of the crank arm. Knowing the tolerances specified on the crank arm, a closed form set of equations were derived to predict the tolerance stack up in the position of the sliding member at any desired configuration of the mechanism. The tolerance analysis was then extended to a group of assemblies of the mechanism.

CHAPTER IV

TOLERANCE ANALYSIS OF A ONE-WAY CLUTCH

4.1 Description of a one-way clutch

A typical one-way clutch is shown in Figure 4-1. A clockwise rotation of the ring causes the roller to wedge between the ring and the hub, forcing the hub to rotate with the ring. The rollers disengage as the ring rotates counter-clockwise, allowing the hub to remain stationary as the ring rotates. This type of clutch is commonly used in lawn mower pull starter assemblies.

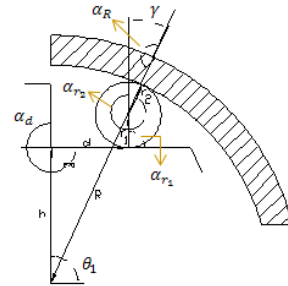
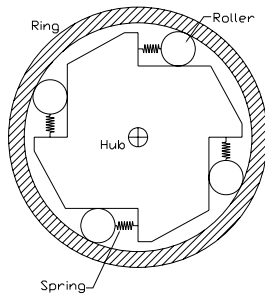

Figure 4-1 Schematic view of a one-way clutch

Figure 4-2 Vector loop of the one-way clutch

Referring to Figure 4-2, the pressure angle “ γ ”, has to be between 5 and 9 degrees for the clutch to operate properly. Angles larger than 9 degrees prevent the clutch from engaging, while angles smaller than 5 degrees may cause an

undesirable condition of self-locking and prevent the clutch from disengaging. The ideal pressure angle is 7 degrees¹. Dimensional variations of length “d” and angle “γ” are dictated by the dimensional variations (tolerances) specified in the hub’s shoulder “h”, the roller radius “r”, and the ring radius “R”.

The tolerance analysis presented in this chapter considers only the engaged position of the clutch. Other positions of the clutch are not critical, therefore, allowing us to view the clutch as a static assembly. In this chapter, once again, the relationship between kinematic and tolerance analyses is demonstrated. A final tolerance analysis, using the kinematic formulation will then be presented in Section 4.3.

4.2 Tolerance analysis of a one-way clutch using a vector loop

The vector loop from Figure 4.2 yields the following vector equation:

$$h e^{i\theta_1} + d e^{i(\theta_1 + \alpha_d)} + r_1 e^{i(\theta_1 + \alpha_d + \alpha_{r_1})} + r_2 e^{i(\theta_1 + \alpha_d + \alpha_{r_1} + \alpha_{r_2})} + R e^{i(\theta_1 + \alpha_d + \alpha_{r_1} + \alpha_{r_2} + \alpha_R)} = 0 \quad (4-1)$$

1- "General 2-D Tolerance Analysis of Mechanical Assemblies With Small Kinematic Adjustments"

Where $\alpha_{r_2} + \gamma = 360$ and $\alpha_{r_2} = 360 - \gamma$. Here the roller is assumed to be a perfect sphere, where $r_1 = r_2 = r$.

In order to allow placement of manufacture tolerances on different parts of this mechanism parameters h , d , r and R are allowed to have differential variations of dh , dd , dr , dR respectively. Take differential of equation (4-1) yields:

$$\begin{aligned} dh e^{i\theta_1} + dd e^{i(\theta_1 + \alpha_d)} + dr (e^{i(\theta_1 + \alpha_d + \alpha_{r_1})} + e^{i(\theta_1 + \alpha_d + \alpha_{r_1} + \alpha_{r_2})}) + \\ d\alpha_{r_2} r e^{i(\theta_1 + \alpha_d + \alpha_{r_1} + \alpha_{r_2})} + dR e^{i(\theta_1 + \alpha_d + \alpha_{r_1} + \alpha_{r_2} + \alpha_R)} + \\ d\alpha_{r_2} R e^{i(\theta_1 + \alpha_d + \alpha_{r_1} + \alpha_{r_2} + \alpha_R)} = 0 \end{aligned} \quad (4-2)$$

Rearranging Equation 4-2 provides:

$$\begin{aligned} dh e^{i\theta_1} + dd e^{i(\theta_1 + \alpha_d)} + dr (e^{i(\theta_1 + \alpha_d + \alpha_{r_1})} + e^{i(\theta_1 + \alpha_d + \alpha_{r_1} + \alpha_{r_2})}) + \\ d\alpha_{r_2} (r e^{i(\theta_1 + \alpha_d + \alpha_{r_1} + \alpha_{r_2})} + R e^{i(\theta_1 + \alpha_d + \alpha_{r_1} + \alpha_{r_2} + \alpha_R)}) + \\ dR e^{i(\theta_1 + \alpha_d + \alpha_{r_1} + \alpha_{r_2} + \alpha_R)} = 0 \end{aligned} \quad (4-3)$$

Defining a new parameter $d\alpha_{r_2} = -d\gamma$ and substitution it in Equation 4-3 yields:

$$\begin{aligned} dh e^{i\theta_1} + dd e^{i(\theta_1 + \alpha_d)} + dr (e^{i(\theta_1 + \alpha_d + \alpha_{r_1})} + e^{i(\theta_1 + \alpha_d + \alpha_{r_1} + \alpha_{r_2})}) + \\ d\gamma (r e^{i(\theta_1 + \alpha_d + \alpha_{r_1} + \alpha_{r_2})} + R e^{i(\theta_1 + \alpha_d + \alpha_{r_1} + \alpha_{r_2} + \alpha_R)}) + \\ dR e^{i(\theta_1 + \alpha_d + \alpha_{r_1} + \alpha_{r_2} + \alpha_R)} = 0 \end{aligned} \quad (4-4)$$

Tolerance analysis traditionally uses relative angles to describe angular positions.

This is useful since tolerance specifications are often given in relative coordinates.

The vector loop with each vector described using absolute angles given in Equation 4-1 results:

$$h e^{j\theta_1} + d e^{j\theta_d} + r_1 e^{j\theta_{r_1}} + r_2 e^{j\theta_{r_2}} + R e^{j\theta_R} = 0 \quad (4-5)$$

Comparing Equations 4-1 and 4-5 shows the following equalities:

$$\begin{aligned} \theta_d &= \theta_1 + \alpha_d \\ \theta_{r_1} &= \theta_1 + \alpha_d + \alpha_{r_1} \\ \theta_{r_2} &= \theta_1 + \alpha_d + \alpha_{r_1} + \alpha_{r_2} \\ \theta_R &= \theta_1 + \alpha_d + \alpha_{r_1} + \alpha_{r_2} + \alpha_R \end{aligned} \quad (4-6)$$

Substituting the parameters of Equations 4-6 into Equations 4-4 yields:

$$dh e^{j\theta_1} + dd e^{j\theta_d} + dr (e^{j\theta_{r_1}} + e^{j\theta_{r_2}}) - dy (r e^{j\theta_{r_2}} + R e^{j\theta_R}) + dR e^{j\theta_R} = 0 \quad (4-7)$$

Resolving this vector equation into its X and Y components yields two scalar equations:

$$\cos \theta_1 dh + \cos(\theta_d) dd + (\cos \theta_{r_1} + \cos \theta_{r_2}) dr + \cos \theta_R dR + (r \sin \theta_{r_2} + R \sin \theta_R) + \cos \theta_R dR = 0$$

(4-8)

$$\begin{aligned} \sin \theta_1 dh + \sin(\theta_d) dd + (\sin \theta_{r_1} + \sin \theta_{r_2}) dr - (r \cos \theta_{r_2} + R \cos \theta_R) dy + \sin \theta_R dR \\ = 0 \end{aligned}$$

Rewriting Equation 4-8 in matrix form results in Equation 4-9:

$$\begin{bmatrix} \cos\theta_1 & (\cos\theta_{r_1} + \cos\theta_{r_2}) & \cos\theta_R \\ \sin\theta_1 & (\sin\theta_{r_1} + \sin\theta_{r_2}) & \sin\theta_R \end{bmatrix} \begin{Bmatrix} dh \\ dr \\ dR \end{Bmatrix} + \begin{bmatrix} \cos\theta_d & (r\sin\theta_{r_2} + R\sin\theta_R) \\ \sin\theta_d & (-r\cos\theta_{r_2} - R\cos\theta_R) \end{bmatrix} \begin{Bmatrix} dd \\ dy \end{Bmatrix} = 0 \quad (4-9)$$

Equation 4-9 can be used for tolerance analysis of the one way clutch. Here the tolerances in hub shoulder h , roller radius r , and ring radius R are treated as known as previously selected input parameters as dh , dr and dR respectively. The goal in solving equation 4-9 is to estimate the tolerance in the contact angle dy and the contact distance d where the part tolerances dh , dr and dR are known.

The matrices in Equation 4-9 can be defined as [A] and [B] according to Equations 4-10:

$$[A] = \begin{bmatrix} \cos\theta_1 & (\cos\theta_{r_1} + \cos\theta_{r_2}) & \cos\theta_R \\ \sin\theta_1 & (\sin\theta_{r_1} + \sin\theta_{r_2}) & \sin\theta_R \end{bmatrix} \quad (4-10)$$

$$[B] = \begin{bmatrix} \cos\theta_d & (r\sin\theta_{r_2} + R\sin\theta_R) \\ \sin\theta_d & (-r\cos\theta_{r_2} - R\cos\theta_R) \end{bmatrix}$$

Rewriting Equation 4-9 in terms of the newly defined matrices [A] and [B], the unknown tolerances dd and $d\gamma$ are solved from Equation 4-11:

$$[A] \begin{Bmatrix} dh \\ dr \\ dR \end{Bmatrix} + [B] \begin{Bmatrix} dd \\ d\gamma \end{Bmatrix} = 0 \quad (4-11)$$

Equation 4-12 provide the closed form solutions for the tolerances dd and $d\gamma$

$$\begin{Bmatrix} dd \\ d\gamma \end{Bmatrix} = [-B^{-1}A] \begin{Bmatrix} dh \\ dr \\ dR \end{Bmatrix} \quad (4-12)$$

4.3 Parametric analysis of the tolerance analysis of one-way clutch assemblies

In Section 4.2 a closed-form formulation was derived for tolerance analysis of a one-way clutch. This section presents a parametric study of this tolerance analysis for a set of geometric dimensions and their corresponding tolerances of the clutch. Table 4-1 contains the geometric dimensions and the specified tolerances for the parts that are manufactured.

Table 4-1 Nominal dimensions and tolerances for the one-way clutch.

Dimension	Nominal Size	Tolerance
Hub shoulder, h	37.33 mm	0.050 mm
Roller radius, r	11.18 mm	0.010mm
Ring radius, R	60.00 mm	0.0130mm
Contact distance, d	12.45 mm	unknown
Pressure angle, γ	7.0 degrees	unknown

The known parameters of Table 4-1 are employed to find the solutions for Equations 4-12.

For the clutch with dimensions found in table 4.1 the final solution becomes:

$$\begin{Bmatrix} dd \\ dy \end{Bmatrix} = \begin{bmatrix} 1.0385 & 1.7958 & -1.4400 \\ 0.0077 & 0.0152 & -0.0060 \end{bmatrix} \begin{Bmatrix} dh \\ dr \\ dR \end{Bmatrix} \quad (4-12)$$

$$\begin{Bmatrix} dd \\ dy \end{Bmatrix} = \begin{bmatrix} 0.0512 \\ 0.0005 \end{bmatrix}$$

Equation 4-10 can be used to find the variance of d and γ given individual part variations of h , r and R , The tolerance analysis can be used to develop worst case and statistical tolerance models.

4.4 Summary

In this chapter modified kinematic analysis was followed to perform tolerance analysis of a one-way clutch. The motivation for this study is to investigate the effects of the specified tolerances of the individual components of the clutch on the critical contact angle of the rolling elements and the contact distance of the rolling element of the clutch. As it is known in this field of machine design, there exists an optimum angle of 7 degrees that assures the best performance for these clutches. As a design tool, this tolerance analysis can be used to specify the individual part tolerances such that the targeted optimum angle of the system does not deviate drastically from its preferred 7 degrees. The formulation presented in this chapter provides this design tool.

CHAPTER V

SKEWNESS ANALYSIS OF TOLERANCE STACK-UP

FOR A SLIDER-CRANK

5.1 Skewness in tolerance analysis of planer mechanisms

This chapter presents an extension of the tolerance analysis for determining the skewness of the tolerance distributions in a group of assemblies of planer mechanism. In certain assemblies of mechanisms it is desired to specify the tolerances of the individual components such that the resulting stack-up tolerance distribution becomes skewed. One example of such tolerance requirements is the one required for the assembly of shafts inside of sleeve bearings. Other examples include mechanisms that are parts of medical and electronic. In this chapter the method of determining the skewness of tolerance

stack-up is presented for a slider crank mechanism. The next section introduces the concept of skewness in a statistical analysis of a typical random variable distribution.

5.2 Definition of skewness in statistical analysis

In probability theory and statistics, skewness is a measure of the asymmetry of the probability distribution of a real-valued random variable. For a random variable distribution shown in Figure 5-1, the number of occurrence of the random variable is not symmetrically distributed about a “mean” value. As shown in this figure, there are generally a lesser number of occurrences to the right side of the “mean” than those to its left. Here, the distribution is skewed around its “mean” value. In the example of Figure 5-1 the distribution is skewed more to the right of the “mean” value. In other words, the tapering of the distribution is non-symmetric around the “mean. The longer tapering is called “tail” and it provide a visual means for determining the type of skewness exist in a distribution. Therefore, the skewness could be divided into the following two types:

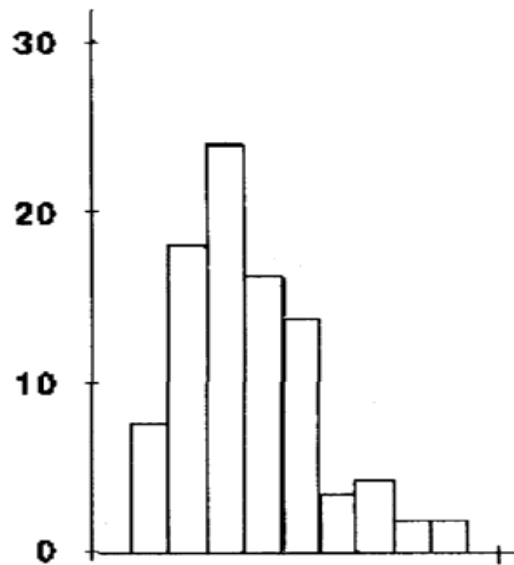

Figure 5-1 Example of experimental data with non-zero skewness

- 1- Positive skewness, shown in Figure 5-2, where the mass (area under curve) of the distribution is concentrated on the left of the figure. The distribution is said to be right-skewed.

- 2- Negative skewness, shown in Figure 5-3, where the mass (area under curve) of the distribution is concentrated on the right of the figure. The distribution is said to be left-skewed.

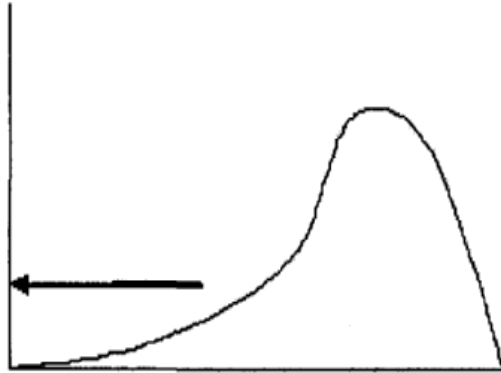

Figure 5-2 Negative Skew

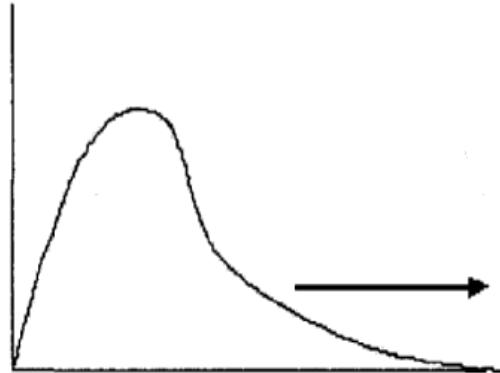

Figure 5-3 Positive Skew

The skewness of the normal distribution (or any perfectly symmetric distribution) is zero. The skewness of a non-symmetric distribution is defined as:

$$y = \frac{\sqrt{n} \sum_{i=1}^n (x_i - \mu)^3}{(\sum_{i=1}^n (x_i - \mu)^2)^{1.5}} \quad (5-1)$$

where “y” is the skewness of the distribution, “n” is the sample size, x_i is the random variable, and “ μ ” is the mean value of the random variable. In MATLAB the skewness of a non-symmetric distribution is calculated according to the syntax:

$$y = \text{skewness}(x) \quad (5-2)$$

where, $y = \text{skewness}(x)$ returns the sample skewness of vector x.

5.3 Skewness in tolerance stack-up for a group of slider-crank assemblies

In chapter 2 the tolerance stack-up of a group of slider-crank assemblies was performed using a kinematic velocity equation approach. Unlike conventional configurations of a slider-crank in which the crank and connecting rod are treated as rigid members in the velocity analysis, in tolerance analysis these rigid links are modified to include sliding features that allow dimensional variations in these links that are encountered in manufacturing processes.

Figures 2-1, 2-2, and 2-3 are shown here again as Figures 5-4, 5-5, and 5-6 respectively. The sliding features incorporated in Figure 5-5 allows the length of the crank and connecting rod to be treated as variables, instead of constants, such variations in turn represent the tolerances that can occur during the manufacturing process of these two components of the slider crank.

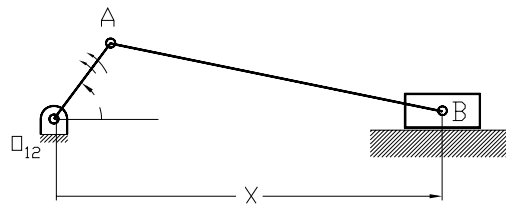

Figure 5-4 Schematic view of a typical slider crank mechanism

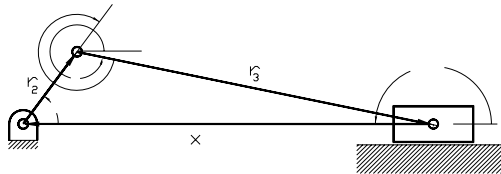

Figure 5-5 Vector loop of a slider crank mechanism

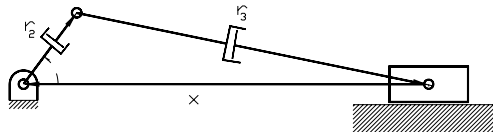

Fig 5-6 The slider crank mechanism with fictitious sliders for tolerance analysis

The vector loop Equation of 2-1 of chapter 2 is re-written here as Equation 5-2:

$$\begin{cases} r_2 \cos \theta_2 + r_3 \cos \theta_3 + x \cos \pi = 0 \\ r_2 \sin \theta_2 + r_3 \sin \theta_3 + x \sin \pi = 0 \end{cases} \quad (5-2)$$

According to Figure 5-6 the lengths r_2 and r_3 are allowed to vary. In Chapter 2 their first variations were treated as the tolerances in their length. Here, their second variations are treated as the skewness in the distributions of these lengths for a group of assemblies of mechanisms shown in Figure 5-4.

Equations 5-3, shown below, are the time derivatives of Equations 5-2:

$$\begin{cases} -r_2 \omega_2 \sin \theta_2 - r_3 \omega_3 \sin \theta_3 + l (\cos \pi) = 0 \\ r_2 \omega_2 \cos \theta_2 + r_3 \omega_3 \cos \theta_3 = 0 \end{cases} \quad (5-3)$$

Where $\dot{\theta}_2 = \omega_2$ and $\dot{\theta}_3 = \omega_3$. The second time derivatives of Equations 5-2 yield:

$$\begin{aligned} r_2 \cos \theta_2 - r_2 \dot{\theta}_2 \sin \theta_2 + r_3 \cos \theta_3 - r_3 \dot{\theta}_3 \sin \theta_3 + l \cos \pi - r_2 \dot{\theta}_2 \sin \theta_2 - r_2 \dot{\theta}_2 \sin \theta_2 \\ - r_2 \dot{\theta}_2 \cos \theta_2 - r_3 \dot{\theta}_3 \sin \theta_3 - r_3 \dot{\theta}_3 \sin \theta_3 - r_3 \dot{\theta}_3^2 \cos \theta_3 = 0 \end{aligned} \quad (5-4)$$

$$\begin{aligned} r_2 \sin \theta_2 + r_2 \dot{\theta}_2 \cos \theta_2 + r_3 \sin \theta_3 + r_3 \dot{\theta}_3 \cos \theta_3 + l \sin \pi - r_2 \dot{\theta}_2 \cos \theta_2 \\ - r_2 \dot{\theta}_2 \cos \theta_2 + r_2 \dot{\theta}_2 \sin \theta_2 - r_3 \dot{\theta}_3 \cos \theta_3 - r_3 \dot{\theta}_3 \cos \theta_3 - r_3 \dot{\theta}_3^2 \sin \theta_3 \\ = 0 \end{aligned}$$

In Equations 5-4 the values of the first and second derivatives of θ are zero:

$$\dot{\theta}_2 = 0 \quad \dot{\theta}_3 = 0$$

In order to interpret Equations 5-4 as skewness analysis, the time derivative characters may be replaced by the “differential” representation, for example:

$$\begin{aligned}
 dr_2 &\rightarrow \dot{r}_2 && \text{known, from tolerance analysis of chapter 2} \\
 dr_3 &\rightarrow \dot{r}_3 && \text{known, from tolerance analysis of chapter 2}
 \end{aligned}
 \tag{5-5}$$

It is the purpose of this analysis to determine the effects of skewness in the distribution of dimensions of r_2 and r_3 on the resulting skewness in the distribution of “x” and “ θ_3 ” of a group of assemblies of the mechanism. Here, all second time derivative parameters are replaced by double differential parameters as shown in Equations 5-6:

$$\begin{cases}
 \ddot{r}_2 = d(dr_2) \\
 \ddot{r}_3 = d(dr_3)
 \end{cases}
 \tag{5-6}$$

Substituting all of the time derivative parameters of Equations 5-4 by their corresponding differential parameters yield:

$$\begin{cases}
 d(dr_2)\cos\alpha_2 + d(dr_3)\cos(\theta_2 + \alpha_2) - 2dr_3d\alpha_3\sin(\theta_2 + \alpha_2) - dx - r_3d\alpha_3\sin(\theta_2 + \alpha_2) \\
 \quad - r_3(d\alpha_3)^2\cos(\theta_2 + \alpha_2) = 0 \\
 d(dr_2)\sin\alpha_2 + d(dr_3)\sin(\theta_2 + \alpha_2) + 2dr_3d\alpha_3\cos(\theta_2 + \alpha_2) + r_3d\alpha_3\cos(\theta_2 + \alpha_2) \\
 \quad - r_3(d\alpha_3)^2\sin(\theta_2 + \alpha_2) = 0
 \end{cases}
 \tag{5-7}$$

Representing Equations 5-6 in a matrix form provide Equations 5-8 as:

$$\begin{bmatrix} -1 & -r_3 \sin(\theta_2 + \alpha_3) \\ 0 & r_3 \cos(\theta_2 + \alpha_3) \end{bmatrix} \begin{Bmatrix} ddx \\ d\alpha_3 \end{Bmatrix} + \begin{bmatrix} \cos\alpha_2 & \cos(\theta_2 + \alpha_3) & -2\sin(\theta_2 + \alpha_3) & r_3 \cos(\theta_2 + \alpha_3) \\ \sin\alpha_2 & \sin(\theta_2 + \alpha_3) & 2\cos(\theta_2 + \alpha_3) & -r_3 \sin(\theta_2 + \alpha_3) \end{bmatrix} \begin{Bmatrix} dd'r_2 \\ dd'r_3 \\ dr_3 d\alpha_3 \\ (d\alpha_3)^2 \end{Bmatrix} = \begin{Bmatrix} 0 \\ 0 \end{Bmatrix} \quad (5-8)$$

stated before, as shown in Equations 5-8, the values of $d(dr_2)$, $d(dr_3)$ are known skewness in the statistical distributions of the lengths of the crank and connecting rods. On the other hand, the values of dr_3 and $d\theta_3$ have been determined in chapter 2 as the outcomes of the tolerance analysis. Let' define the matrices of Equations 5-8 as [A] and [B] as:

$$B = \begin{bmatrix} -1 & -r_3 \sin(\theta_2 + \alpha_3) \\ 0 & r_3 \cos(\theta_2 + \alpha_3) \end{bmatrix}$$

$$A = \begin{bmatrix} \cos\alpha_2 & \cos(\theta_2 + \alpha_3) & -2\sin(\theta_2 + \alpha_3) & r_3 \cos(\theta_2 + \alpha_3) \\ \sin\alpha_2 & \sin(\theta_2 + \alpha_3) & 2\cos(\theta_2 + \alpha_3) & -r_3 \sin(\theta_2 + \alpha_3) \end{bmatrix} \quad (5-9)$$

Solving Equations 5-8, with the [A] and [B] matrices defined in Equations 5-9, the resulting skewness of “x” and “ θ_3 “ can be determined for the distributions of a group of assemblies of the slider crank mechanism as:

$$\begin{Bmatrix} ddx \\ d\alpha_3 \end{Bmatrix} = -B^{-1} A \begin{Bmatrix} dd'r_2 \\ dd'r_3 \\ dr_3 d\alpha_3 \\ (d\alpha_3)^2 \end{Bmatrix} \quad (5-10)$$

5.4 Parametric analysis of the skewness of slider-crank assemblies

In Section 5-3 a closed-form formulation was derived for skewness analysis of a slider crank mechanism. This section presents a parametric study of this skewness analysis for a set of geometric dimensions and their corresponding tolerances of a slider crank mechanism. Table 5-1 contains a summary of the parameters used in this section:

Table 5-1 Known parameters for skewness analysis of a slider crank

Crank length, r_2	Connecting rod length, r_3	θ_2	dr_2	dr_3	θ_3	ddr_2	ddr_3
10	20	45	0.005	0.005	339.3* $\pi/180$	-0.56	= -0.

The known parameters of Table 5-1 are employed to find the solutions for Equations 5-7. Table 5-2 contains the results of this parametric study.

Table 5-2 Skewness of the slider position and connecting rod angle

Skewness in X	Skewness in θ_3
-0.9625	-0.0113

5.5 Summary

The tolerance analyses presented in this thesis is mainly founded on the vector loop kinematic “velocity” formulation of mechanisms. Such velocity analyses enable a designer to substitute the velocities of the individual components of a mechanism with first “differential” parameters that stem from incorporation of fictitious sliding members in the mechanism. The virtual displacements of these fictitious sliders are then interpreted as the dimensional manufacturing tolerances of the individual components. Chapter 5 of this thesis extends this method of tolerance analysis to a statistical “skewness” analyses. This is accomplished by working with the second time derivatives of the kinematic position equations, namely the acceleration analysis of the mechanism. Here, the acceleration parameters of a kinematic system, having fictitious sliders, are replaced by the second differentials of the displacements of these fictitious sliders and thereby are interpreted as the second variations in the geometric dimensions of the mechanism. In other words, the skewness of the tolerance distributions may be determined via the closed-form formulations developed in this chapter for any configurations of the kinematic system.

CHAPTER VI

CONCLUSIONS AND FUTURE WORK

6.1 Conclusions

A kinematic based tolerance analysis of mechanisms was introduced in this work. It was shown that standard kinematic analysis can be used for tolerance analysis of a mechanism and linkages for obtaining a closed-form formulation. In the presented approach the manufacturing tolerances are accounted for by incorporating fictitious sliding members in the rigid links, thereby allowing them to either “grow” or “shrink” along the lines of their pin connections. The virtual expansions or contractions of these fictitious sliders can be captured in by taking the differential of the magnitudes of the vectors that define the length of rigid links having dimensional tolerances. These

mathematical differentiations follow exactly the procedure of kinematic velocity analyses of mechanisms. The method can further be extended to perform tolerance analysis on a group of identical mechanisms.

As the fictitious sliders are added to the rigid members of a mechanism, a modified linkage is constructed with higher number of degrees of freedom (DOF) that requires higher number of kinematic input parameters in order to obtain unique kinematic solutions. The extra required input parameters however are the known tolerances of the individual parts that result in obtaining a unique solution for the tolerance analysis of a mechanism in a general explicit form for any configuration of the system.

The tolerance analysis presented in this thesis was utilized to study tolerance stack ups in three (3) different mechanisms, slider crank, Scotch-Yoke, and a one-way clutch. In each case, the effect of tolerances in the individual components were combined together, through modified kinematic analyses in order to determine the resulting stack up of tolerances in the assembly of the parts for any generalized configuration of the mechanisms.

The analysis was further extended to include statistical skewness analyses on the tolerance distributions of the individual components and the resulting skewness on the assembly of the mechanism.

The main benefit of the presented approach is the use of standard kinematic solver computer codes for tolerance analyses of mechanisms. Incorporating fictitious slider in a mechanism is interpreted by these coded as additional degrees of freedom, with the corresponding input parameters known as the individual tolerance of the machine components.

6.2 Future work

The present work can be expanded to the following areas of tolerance analyses of machine assemblies:

- Tolerance analysis of spatial mechanisms
- Inclusion of part deformation as the results of the interacting loads among the machine components

References

1. Chase, K. W., Gao, J. and Maglebly, A. P., 1995, "*General 2-D Tolerance Analysis of Mechanical Assemblies With Small Kinematic Adjustments,*" ADCATS Publication # 94-1, pp1 - 18.
2. Huo, Hanqi, 1995, "*New Tolerance Analysis Methods for preliminary Design in Mechanical Assemblies,*" Ph.D. Dissertation, Brigham Young University.
3. Lee, S.J., and Gilmore, B.J., 1991, "*The Determination of the Probabilistic properties of Velocities and Accelerations in Kinematic Chains with Uncertainty,*" Journal of Mechanical Design, Vol. 113, pp 84-90.
4. Liou, Y. H., Lin, P. P., Lindeke, R. R. and Chiang, H. D., 1993, "*Tolerance Specification of Robot Kinematic Parameters Using an Experimental Design Technique - the Taguchi Method,*" Journal of Robotics & Computer - Integrated Manufacturing, Vol. 10, No. 3, pp 199-207.
5. Hartenberg, R.S., and Denavit, J., 1964, *Kinematic Synthesis of linkages,* McGraw-Hill.
6. Knappe, L.F., 1963, "*A Technique for Analyzing Mechanism Tolerances,*" ASME, Journal of Machine Design, April 25, pp 155-157.

7. Marler, Jaren D., 1988, "*Nonlinear Tolerance Analysis Using the Direct Linearization*", Master Thesis, Brigham Young University.
8. Hald, A., 1952, "*Statistical Theory with Engineering Application*", New York, John Wiley & Son, Inc.
9. Lindman, H. R., 1992, "*Analysis of Variance in Experimental Design* " Springer-Verlag New York Inc.